

INSTALLATION INSTRUCTIONS



DXV Modulus™ Countertop Slab Single/Double

75" Model D19035075 Series

90" Model D19040090 Series

Thank you for selecting DXV. To ensure this product is installed properly, please read these instructions carefully before you begin. (Certain installations may require professional help.) Also be sure your installation conforms to local codes.

To maintain the beauty of the finish, avoid placing the furniture in direct sunlight, as sunlight causes fading. Also avoid extreme changes in temperature by arranging furniture away from radiators, heat and air vents, and air conditioning units. Avoid placing furniture directly under windows.

⚠ CAUTION: PRODUCT IS FRAGILE. TO AVOID BREAKAGE AND POSSIBLE INJURY HANDLE WITH CARE!

RECOMMENDED TOOLS AND MATERIALS

Most of the procedures require the use of common tools and materials, which are available from hardware and plumbing supply stores. It is essential that the tools and materials be on hand before work has begun.

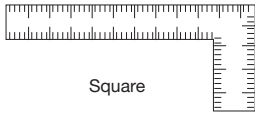

Square



Level

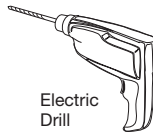

Electric Drill



Tape Measure

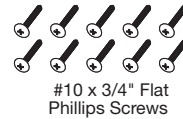

#10 x 3/4" Flat Phillips Screws



#14 1-1/2" Lag Screw

ROUGHING-IN DIMENSIONS:

- For reference

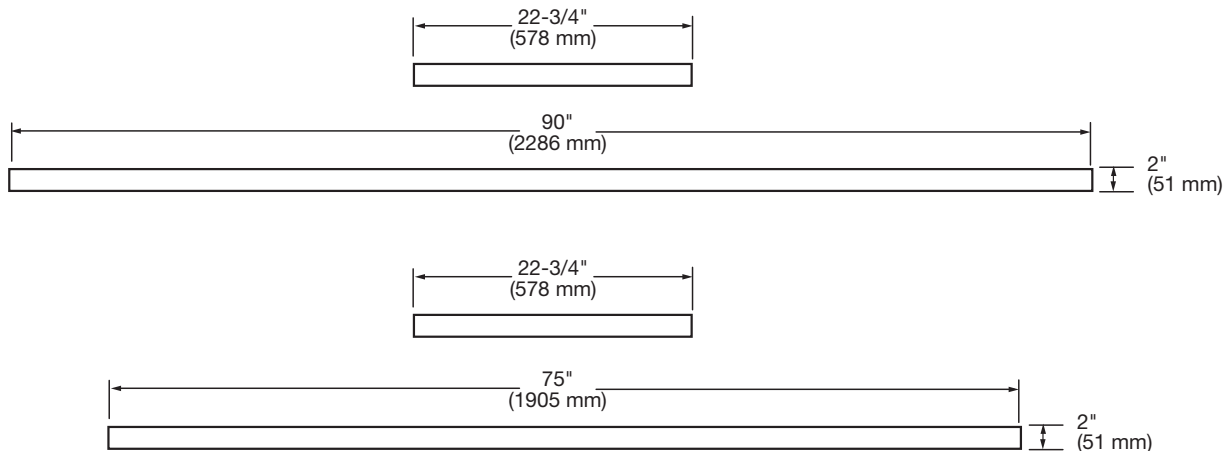

S A V E F O R F U T U R E U S E

COUNTERTOP SLAB INSTALLATION

- Studded walls must be exposed for installation of brackets.
- Once a final height for the sink is determined, subtract 6 -3/4" (155 mm) to mark the bottom area of the bracket. **Figure 1.**
- Each bracket needs to be attached to a 2x4 stud. If a stud is not available for the bracket location selected, one must be provided for support of the bracket. **Figure 2.**
- Mount each bracket centerline of the 2x4 using #14 1-1/2" Lag Screws. Ensure each bracket is level and mounted at the correct predetermined height.
- Install all waterproof drywall as usual and around each bracket before installing countertop slab. **Figure 3.**
- Place countertop slab on top of brackets and up against surface of wall with no gaps and level. Also ensure that a bracket does not interfere with the bottom of the sink or the drain/water supply once installed. **Figure 4.**
- Attach the countertop slab to the brackets using #10-3/4" wood screws. Screws should be installed only through the large hole under the bracket.

Figure 1.

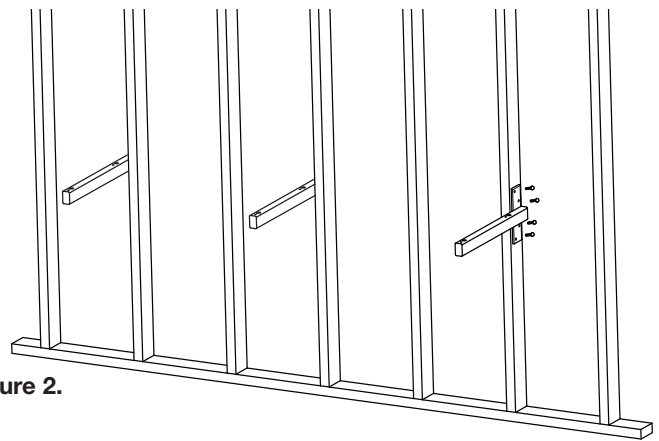
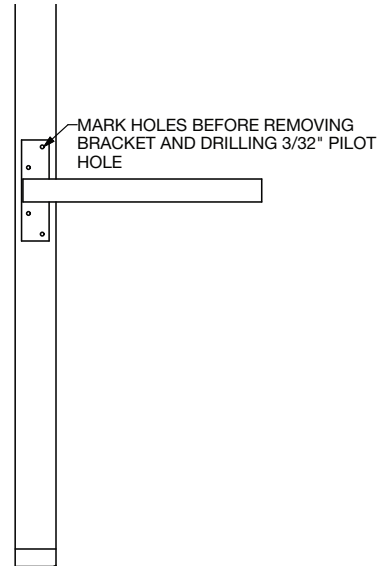

Figure 2.

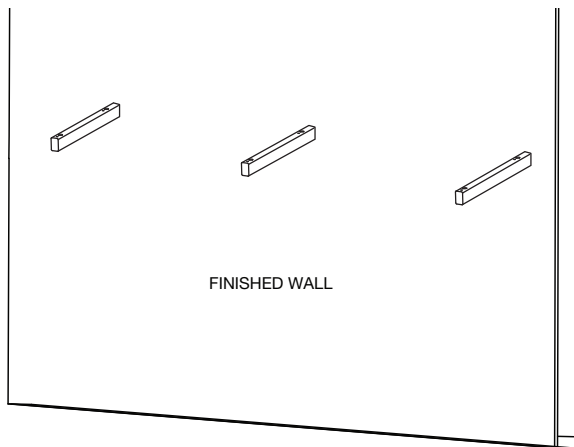

Figure 3.

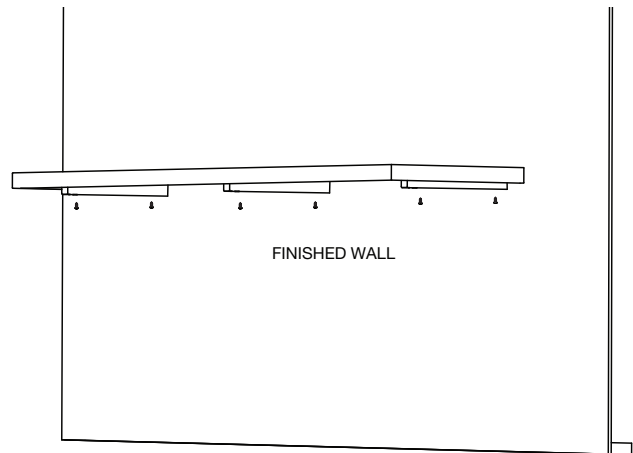

Figure 4.

In the United States:

DXV
One Centennial Avenue
Piscataway, New Jersey 08855
Attention: Director of Customer Care

For residents of the United States, warranty information may also be obtained by calling the following toll free number: (800) 227-2734
www.DXV.com

In Canada:

DXV
5900 Avebury Road
Mississauga, Ontario
L5R 3M3
Canada

Toll Free: 1-800-387-0369
Local: 905-306-1093
Fax: 1-800-395-1498
www.DXV.ca

In Mexico:

DXV
Vía Morelos 330
Col. Santa Clara Coatitla
Ecatepec, Estado de México 55540

Toll Free: 01-800-8391200
www.DXV.mx